

FRONT VIEW

DATE 01-07-2023	DRAWN BY B.G.	MODEL TR-5199F
PRODUCT RACK MOUNT VERSION	REVISION 0	SCALE NTS
FINISH CRINKLE BLACK POWDER PAINT	Transduction	CHECKED BY
TITLE LAYOUT	DRAWING No B-752	

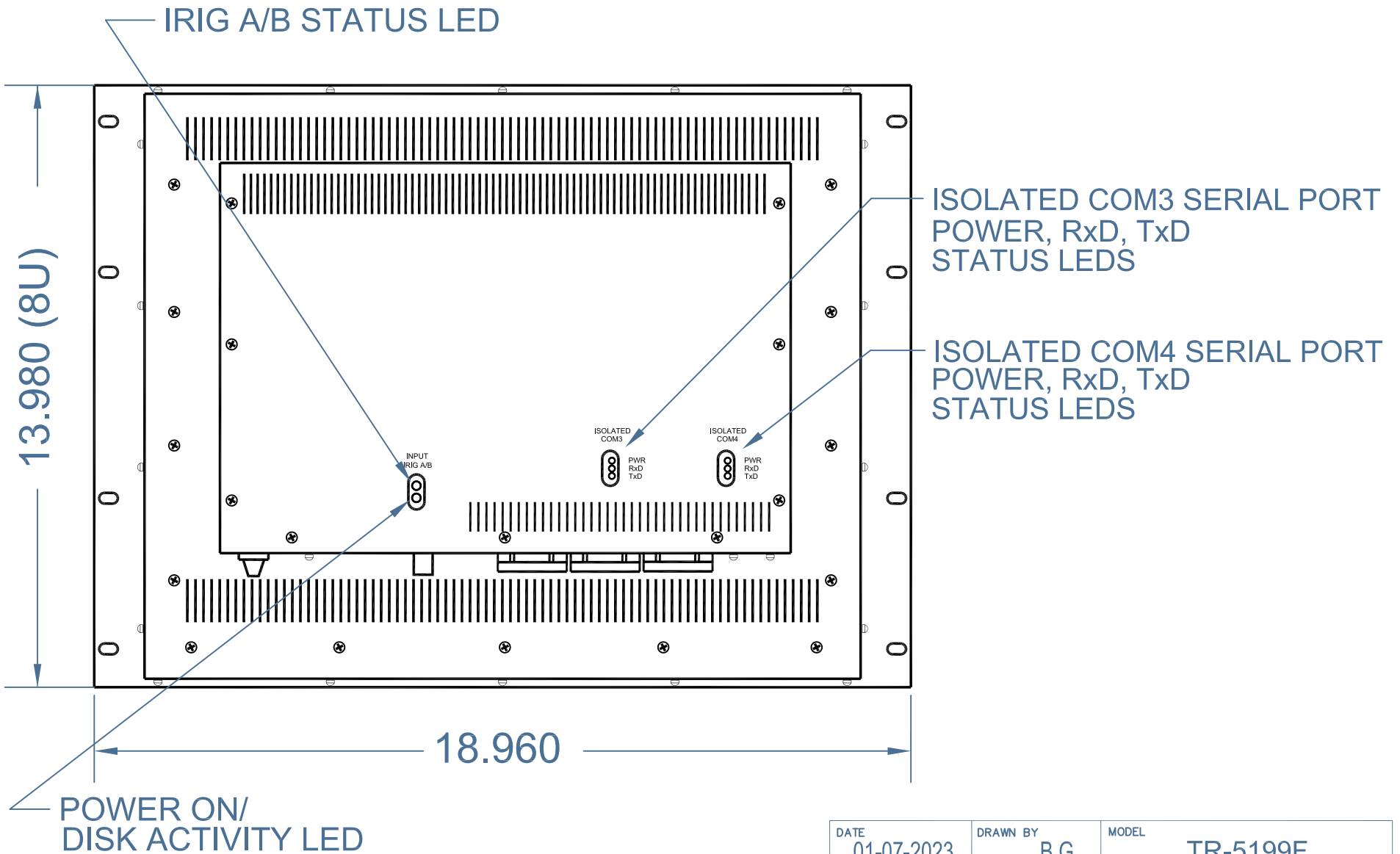

REAR VIEW

DATE 01-07-2023	DRAWN BY B.G.	MODEL TR-5199F
PRODUCT RACK MOUNT VERSION	REVISION 0	SCALE NTS
FINISH CRINKLE BLACK POWDER PAINT	Transduction	CHECKED BY
TITLE LAYOUT	DRAWING No B-753	

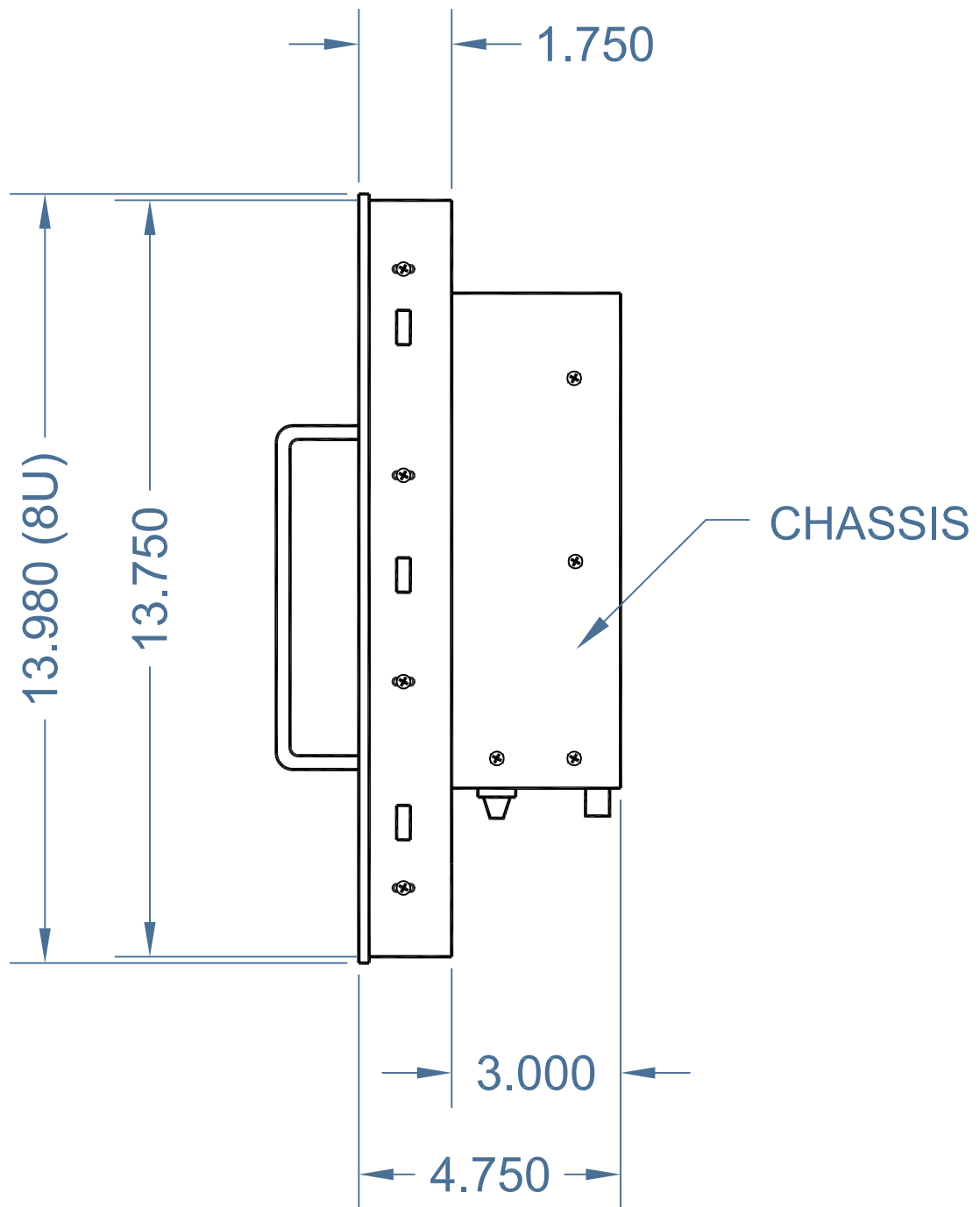

RIGHT SIDE VIEW

DATE 01-07-2023	DRAWN BY B.G.	MODEL TR-5199F		
PRODUCT RACK MOUNT VERSION		REVISION 0	SCALE NTS	
FINISH CRINKLE BLACK POWDER PAINT	Transduction		CHECKED BY	NTS
TITLE LAYOUT			DRAWING No B-754	

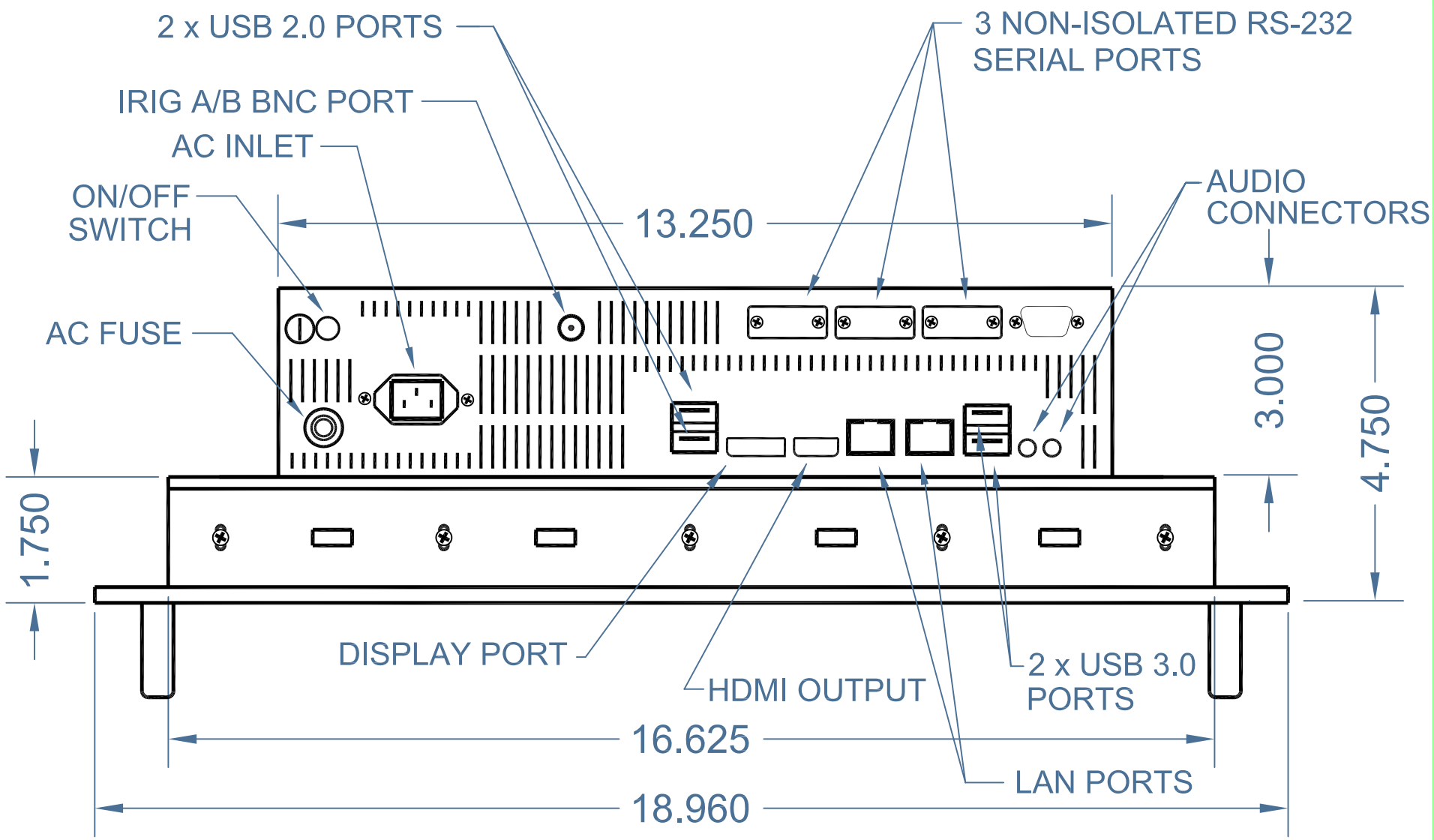

BOTTOM VIEW

DATE 01-07-2023	DRAWN BY B.G.	MODEL TR-5199F
PRODUCT RACK MOUNT VERSION		REVISION 0
FINISH CRINKLE BLACK POWDER PAINT	Transduction	CHECKED BY NTS
TITLE LAYOUT AC INPUT OPTION		DRAWING No B-755

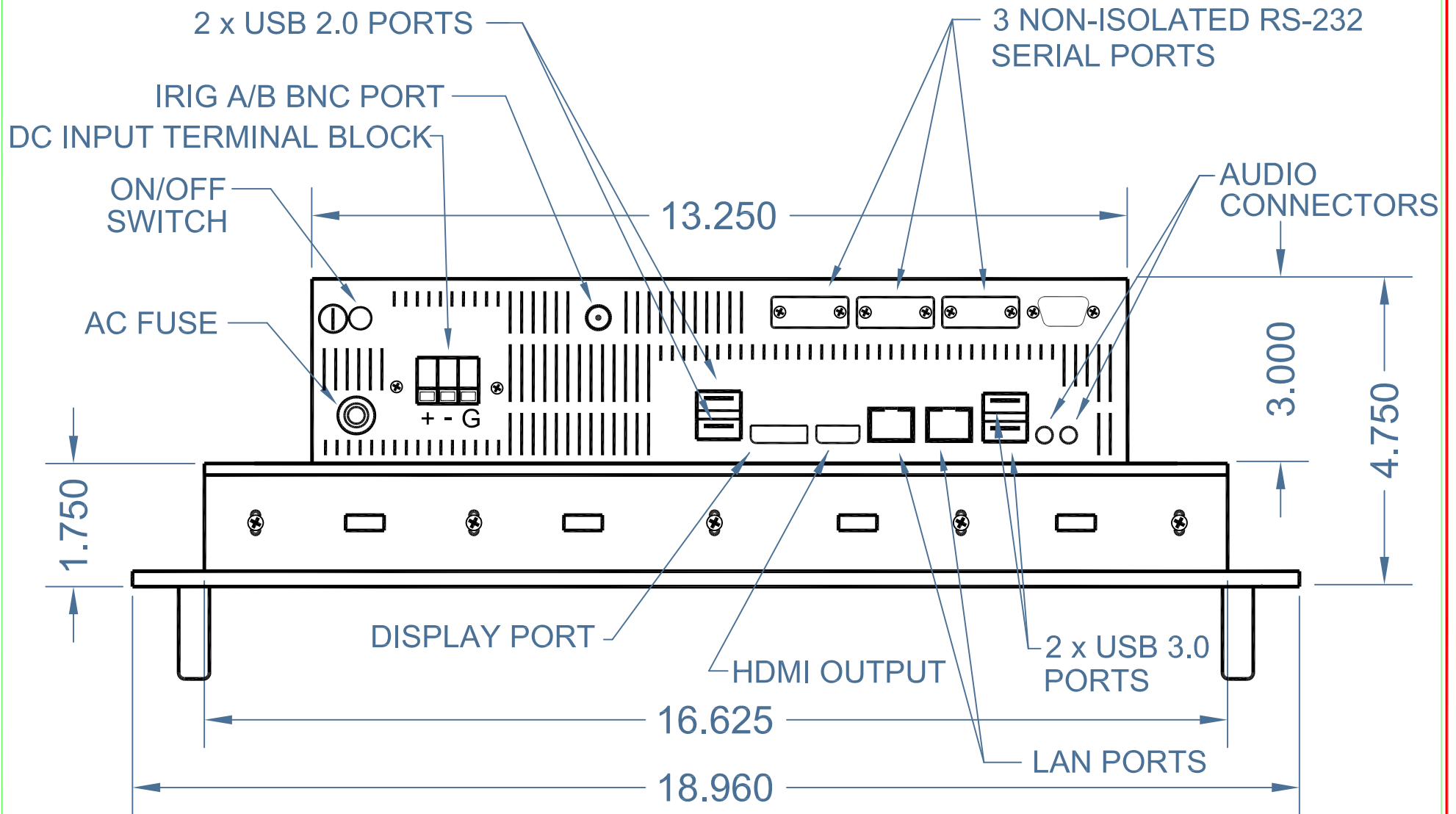

BOTTOM VIEW

DATE 01-07-2023	DRAWN BY B.G.	MODEL TR-5199F
PRODUCT RACK MOUNT VERSION	REVISION 0	SCALE NTS
FINISH CRINKLE BLACK POWDER PAINT		
TITLE LAYOUT DC INPUT OPTION	DRAWING No B-756	

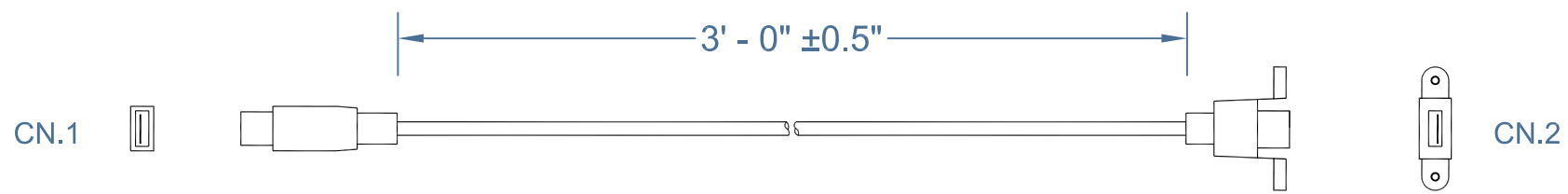
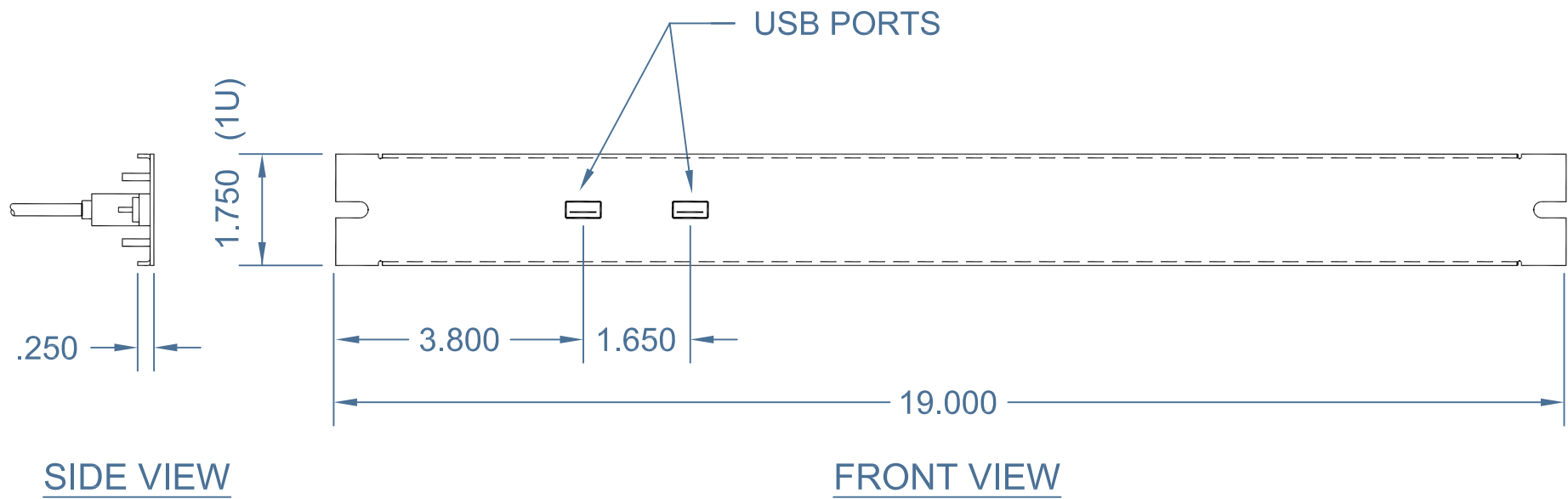

TWO USB CABLES
MOUNTED ON THE PLATE

DATE	DRAWN BY	MODEL		
02-01-2010	B.G.	1U USB FILLER		
TR-RM-USB PLATE			REVISION	SCALE
			0	NTS
FINISH	SANDTEX BLACK PAINT		CHECKED BY	
TITLE			DRAWING No	
LAYOUT			B-436A	